

## Datasheet



- Compact, rugged, low cost self-contained sensors in metal die cast housings
- Epoxy-encapsulated circuitry; leakproof IP67 (NEMA 6) construction for harsh environments
- Outstanding electrical noise immunity
- Dual LED system indicates sensor performance
- Choice of integral cable or quick disconnect connector



**WARNING: Not To Be Used for Personnel Protection**

Never use this device as a sensing device for personnel **protection**. Doing so could lead to serious injury or death. This device does not include the self-checking redundant circuitry necessary to allow its use in personnel safety applications. A sensor failure or malfunction can cause either an energized or de-energized sensor output condition.

## Models

QM42 Opposed Mode <b>Emitter (E)</b> and Receiver (R)		
Models	Cable	Output Type
QM426E Emitter	2 m (6.5 ft)	-
QM426EQ Emitter	4-pin Euro QD	
QM42VN6R Receiver	2 m (6.5 ft)	NPN
QM42VN6RQ Receiver	4-pin Euro QD	
QM42VP6R Receiver	2 m (6.5 ft)	PNP
QM42VP6RQ Receiver	4-pin Euro QD	

QM42 <b>Plastic Fiber Optic Mode</b>		
Models	Cable	Output Type
QM42VN6FP	2 m (6.5 ft)	NPN
QM42VN6FPQ	4-pin Euro QD	
QM42VP6FP	2 m (6.5 ft)	PNP
QM42VP6FPQ	4-pin Euro QD	

QM42 <b>Diffuse Mode</b>		
Models	Cable	Output Type
QM42VN6D	2 m (6.5 ft)	NPN
QM42VN6DQ	4-pin Euro QD	
QM42VP6D	2 m (6.5 ft)	PNP
QM42VP6DQ	4-pin Euro QD	

QM42 Polarized <b>Retroreflective Mode</b>		
Models	Cable	Output Type
QM42VN6LP	2 m (6.5 ft)	NPN
QM42VN6LPQ	4-pin Euro QD	
QM42VP6LP	2 m (6.5 ft)	PNP
QM42VP6LPQ	4-pin Euro QD	

To order the 9 m (30 ft) cable models, add the suffix "W/30" to the model number of any cabled sensor (for example, QM42VN6D W/30). Models with a QD connector require a mating cable.

## Specifications

### Sensing Beam

Infrared, 880 nm for opposed and diffuse  
Visible red, 660 nm for fiber optic and retroreflective modes

### Supply Voltage and Current

10 to 30 V dc (10% maximum ripple) at less than:  
Diffuse and retroreflective models: 20 milliamps  
Opposed mode: 30 milliamps (emitter), 10 milliamps (receiver)  
Fiber optic models: 30 milliamps

### Supply **Protection** Circuitry

Protected against reverse polarity and transient voltages

### Output **Configuration**

SPDT (complementary) solid-state dc switch; Choose NPN (current sinking) or PNP (current sourcing) models.  
Light operate: N.O. output conducts when the sensor sees its own (or the emitter's) modulated light  
Dark operate: N.C. output conducts when the sensor sees dark

### Output **Rating**

100 mA maximum (each output)  
Off-state leakage current: < 5 microamps at 30 V dc  
On-state saturation voltage: < 1 V at 10 mA dc; < 1.5 V at 100 mA dc

### Repeatability

Diffuse and retroreflective modes: 250 microseconds  
Opposed Mode: 120 microseconds  
Fiber optic mode: 60 microseconds

### Adjustments

All models except emitters: 15-turn slotted brass GAIN (sensitivity) adjustment potentiometer (clutched at both ends of travel)

### Indicators

Two LEDs: green and amber  
Green solid = power to sensor is on (Opposed emitters: Green power "on")  
Green flashing = output is overloaded  
Amber solid = light is sensed; normally open output on  
Amber flashing = marginal excess gain (1-1.5x) in light condition

### Construction

Housings are die-cast zinc alloy with black epoxy powder paint finish; lenses are acrylic

### Connections

2 m (6.5 ft) or 9 m (30 ft) attached cable, or 4-pin Euro-style quick-disconnect fitting; Cables for QD models are purchased separately



**Output Protection Circuitry**

Protected against false pulse on power-up and continuous overload or short-circuit of outputs  
 Overload trip point  $\geq 150$  mA, typical, at 20 °C

**Output Response Time**

Diffuse and retroreflective modes: 1 millisecond on and off  
 Opposed mode: 1 millisecond on, 0.5 millisecond off  
 Fiber optic mode: 0.25 millisecond on and off

**Environmental Rating**

IP67; NEMA 6

**Operating Conditions**

Temperature: -20 °C to +70 °C (-4 °F to +158 °F)  
 Relative Humidity: 90% at +50 °C maximum relative humidity (non-condensing)

**Certifications**



**Required Overcurrent Protection**



**WARNING:** Electrical connections must be made by qualified personnel in accordance with local and national electrical codes and regulations.

Overcurrent protection is required to be provided by end product application per the supplied table.  
 Overcurrent protection may be provided with external fusing or via Current Limiting, Class 2 Power Supply.  
 Supply wiring leads < 24 AWG shall not be spliced.  
 For additional product support, go to [www.bannerengineering.com](http://www.bannerengineering.com).

Supply Wiring (AWG)	Required Overcurrent Protection (Amps)
20	5.0
22	3.0
24	2.0
26	1.0
28	0.8
30	0.5

**Performance Curves**

**Plastic Fiber Optic Mode - Range: 40 mm (1.5 in)**

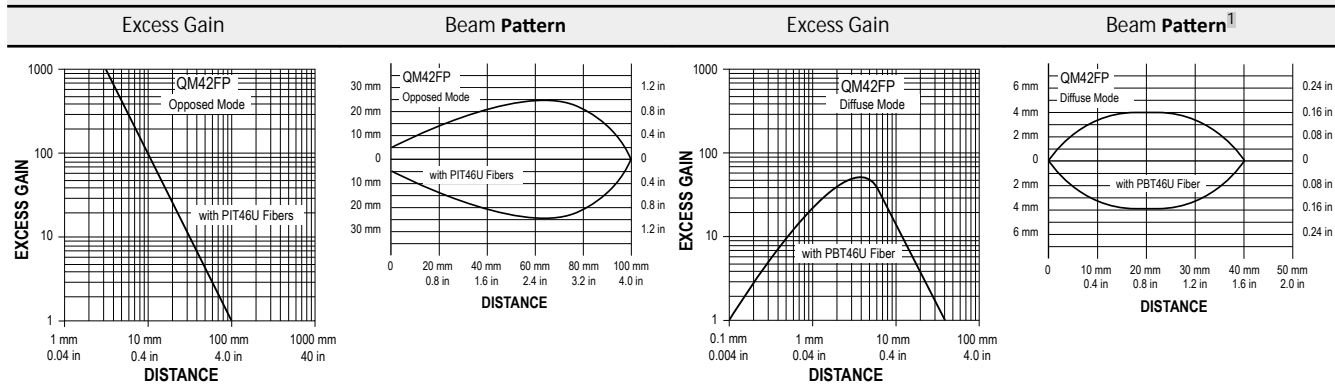

**Opposed Mode - Range: 10 m (33 ft)**

**Diffuse Mode - Range: 400 mm (16 in)**

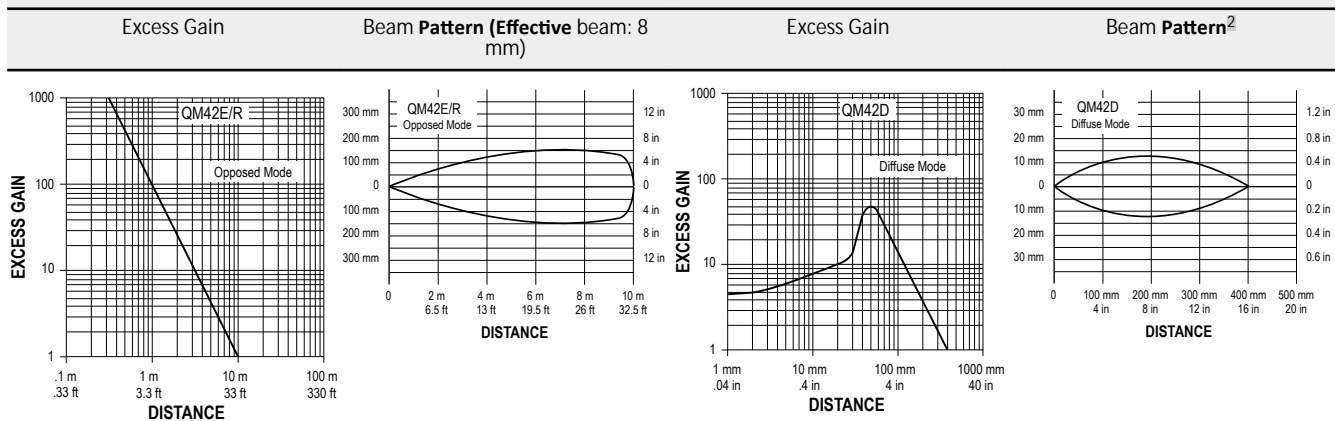

<sup>1</sup> Diffuse mode performance is based on a 90% reflectance white test card.  
<sup>2</sup> Performance is based on a 90% reflectance white test card.

Polarized **Retroreflective** Mode - Range: 3 m (10 ft)

Excess Gain

Beam Pattern

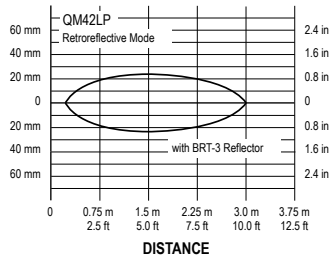
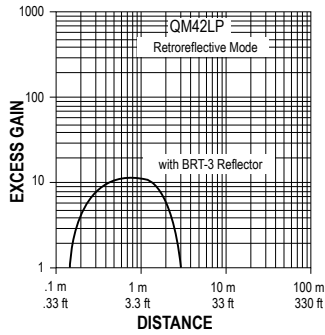

Dimensions

Cabled **Diffuse**, **Opposed**, and **Retroreflective** Models

Quick Disconnect Models

Quick Disconnect FP Models

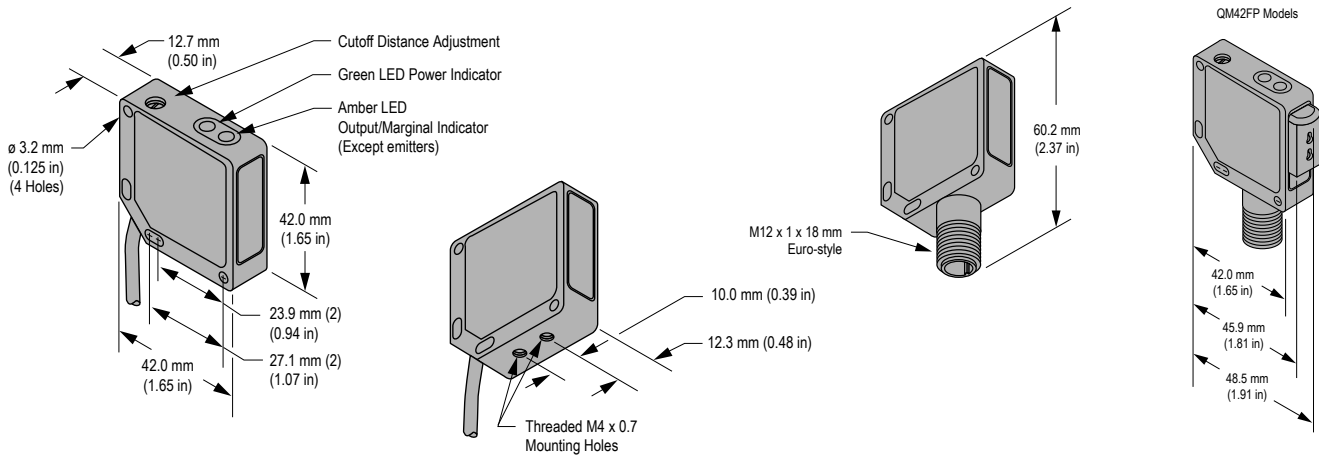

Wiring Diagrams

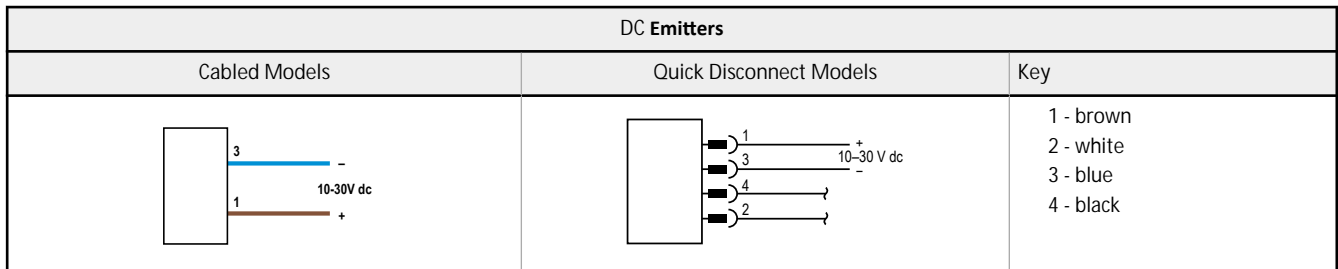
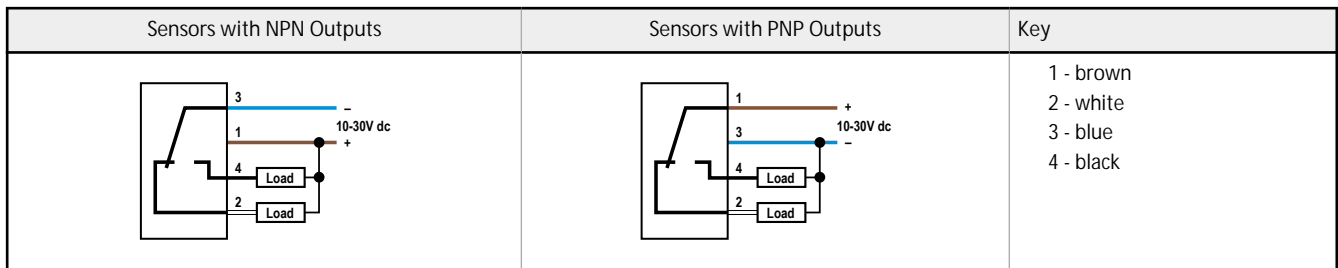

Cabled models are shown. Quick disconnect (QD) wiring diagrams are functionally identical.

## Accessories

### 4-Pin Euro-Style Cordsets

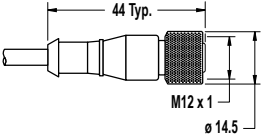
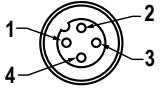
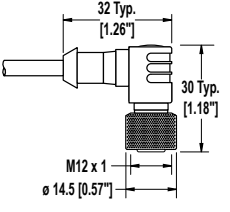
4-Pin Threaded M12/Euro-Style Cordsets				
Model	Length	Style	Dimensions	Pinout (Female)
MQDC-406	1.83 m (6 ft)	Straight		 <p>1 = Brown 2 = White 3 = Blue 4 = Black</p>
MQDC-415	4.57 m (15 ft)			
MQDC-430	9.14 m (30 ft)			
MQDC-450	15.2 m (50 ft)			
MQDC-406RA	1.83 m (6 ft)	Right-Angle		
MQDC-415RA	4.57 m (15 ft)			
MQDC-430RA	9.14 m (30 ft)			
MQDC-450RA	15.2 m (50 ft)			

### Brackets

SMB19

- Right-angle mounting bracket with a curved slot for versatile orientation

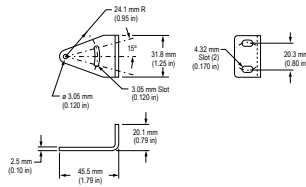

All measurements are listed in millimeters [inches], unless noted otherwise.

## Banner Engineering Corp. Limited Warranty

Banner Engineering Corp. warrants its products to be free from defects in material and workmanship for one year following the date of shipment. Banner Engineering Corp. will repair or replace, free of charge, any product of its manufacture which, at the time it is returned to the factory, is found to have been defective during the warranty period. This warranty does not cover damage or liability for misuse, abuse, or the improper application or installation of the Banner product.

THIS LIMITED WARRANTY IS EXCLUSIVE AND IN LIEU OF ALL OTHER WARRANTIES WHETHER EXPRESS OR IMPLIED (INCLUDING, WITHOUT LIMITATION, ANY WARRANTY OF MERCHANTABILITY OR FITNESS FOR A PARTICULAR PURPOSE), AND WHETHER ARISING UNDER COURSE OF PERFORMANCE, COURSE OF DEALING OR TRADE USAGE.

This Warranty is exclusive and limited to repair or, at the discretion of Banner Engineering Corp., replacement. IN NO EVENT SHALL BANNER ENGINEERING CORP. BE LIABLE TO BUYER OR ANY OTHER PERSON OR ENTITY FOR ANY EXTRA COSTS, EXPENSES, LOSSES, LOSS OF PROFITS, OR ANY INCIDENTAL, CONSEQUENTIAL OR SPECIAL DAMAGES RESULTING FROM ANY PRODUCT DEFECT OR FROM THE USE OR INABILITY TO USE THE PRODUCT, WHETHER ARISING IN CONTRACT OR WARRANTY, STATUTE, TORT, STRICT LIABILITY, NEGLIGENCE, OR OTHERWISE.

Banner Engineering Corp. reserves the right to change, modify or improve the design of the product without assuming any obligations or liabilities relating to any product previously manufactured by Banner Engineering Corp. Any misuse, abuse, or improper application or installation of this product or use of the product for personal protection applications when the product is identified as not intended for such purposes will void the product warranty. Any modifications to this product without prior express approval by Banner Engineering Corp will void the product warranties. All specifications published in this document are subject to change; Banner reserves the right to modify product specifications or update documentation at any time. Specifications and product information in English supersede that which is provided in any other language. For the most recent version of any documentation, refer to: [www.bannerengineering.com](http://www.bannerengineering.com).